



LED WALL LIGHT 2X5W - SERIES A
PRODUCT OUTDOOR



LED WALL LIGHT 2X5W

SPECCIFICATION

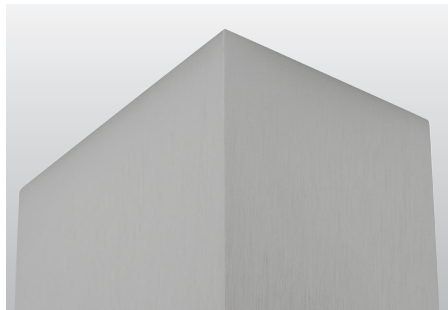
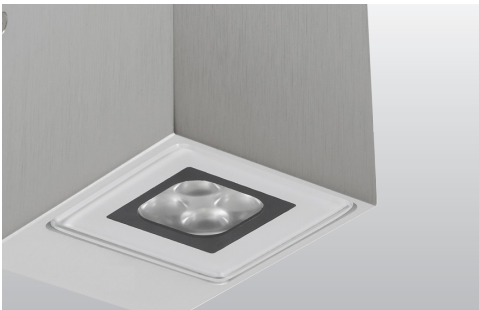

SPECCIFICATION

- Order Code: WA010
- Input Voltage: 24VDC, 220V
- Dimension: L80xW60xH110mm
- Chip LED: CREE
- Power consumption: 10W
- Lumen Output: 2x450 lm
- Material: Aluminium
- Efficiency: 90%
- Environment temperature: from -30° to 60°C
- Color[CRI]: 3000K, 4000k, 5000k
- CRI: >90
- Beam angle: 12° 24° 36° 50°
- IP Rating: IP65
- Life time: 50.000 hour
- Control: ON/OFF, DIM 0 - 10V, DALI, DMX512
- Standards:
 - + RoHS; EMC protection
 - + IEC 62031LED
 - + IEC 60598 Luminaires



LED WALL LIGHT 2X5W

TECHNICAL DETAILS

TECHNICAL DETAILS

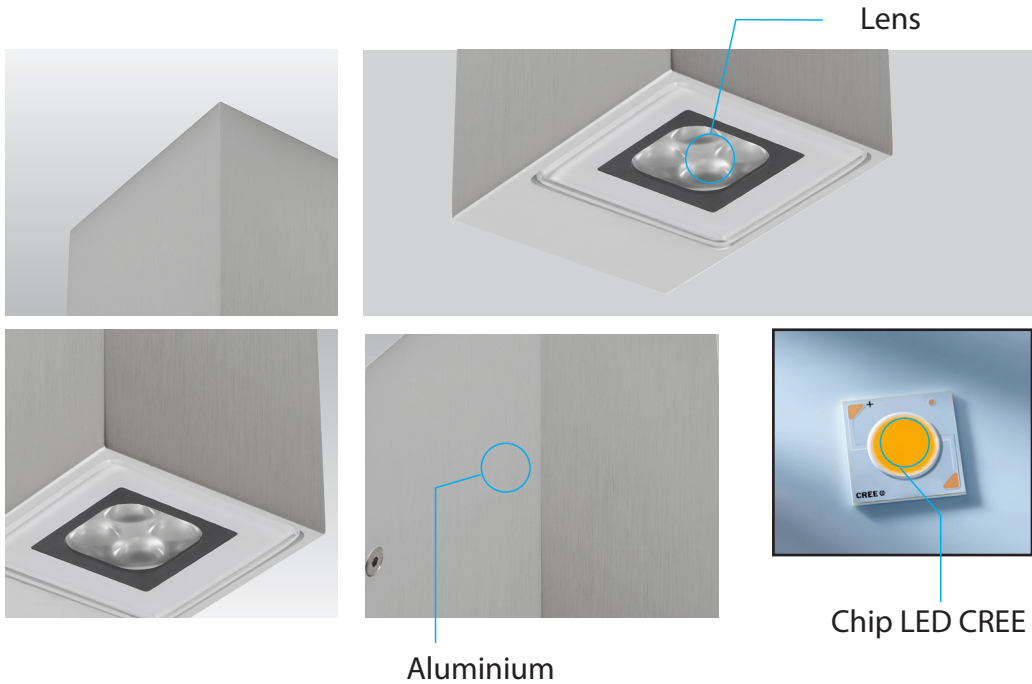

Select Color XX

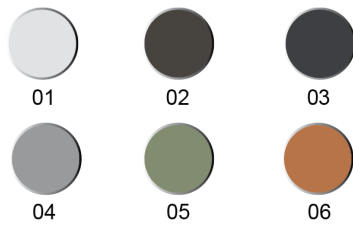

DIMENSIONS

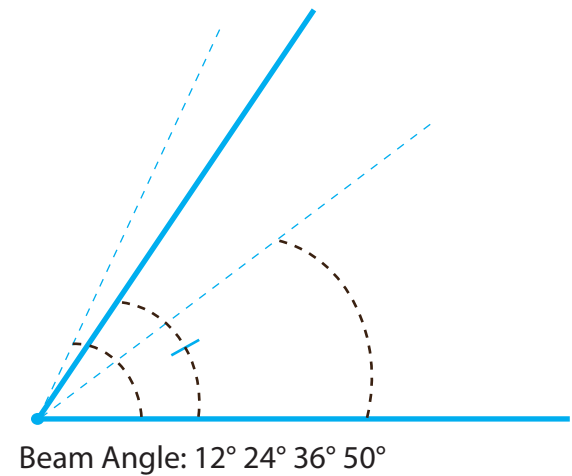
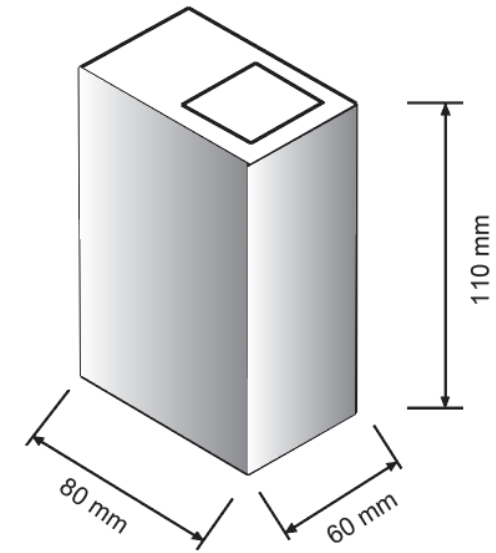

LED WALL LIGHT 2X5W

POWER SUPPLIES - INPUT VOTAGE

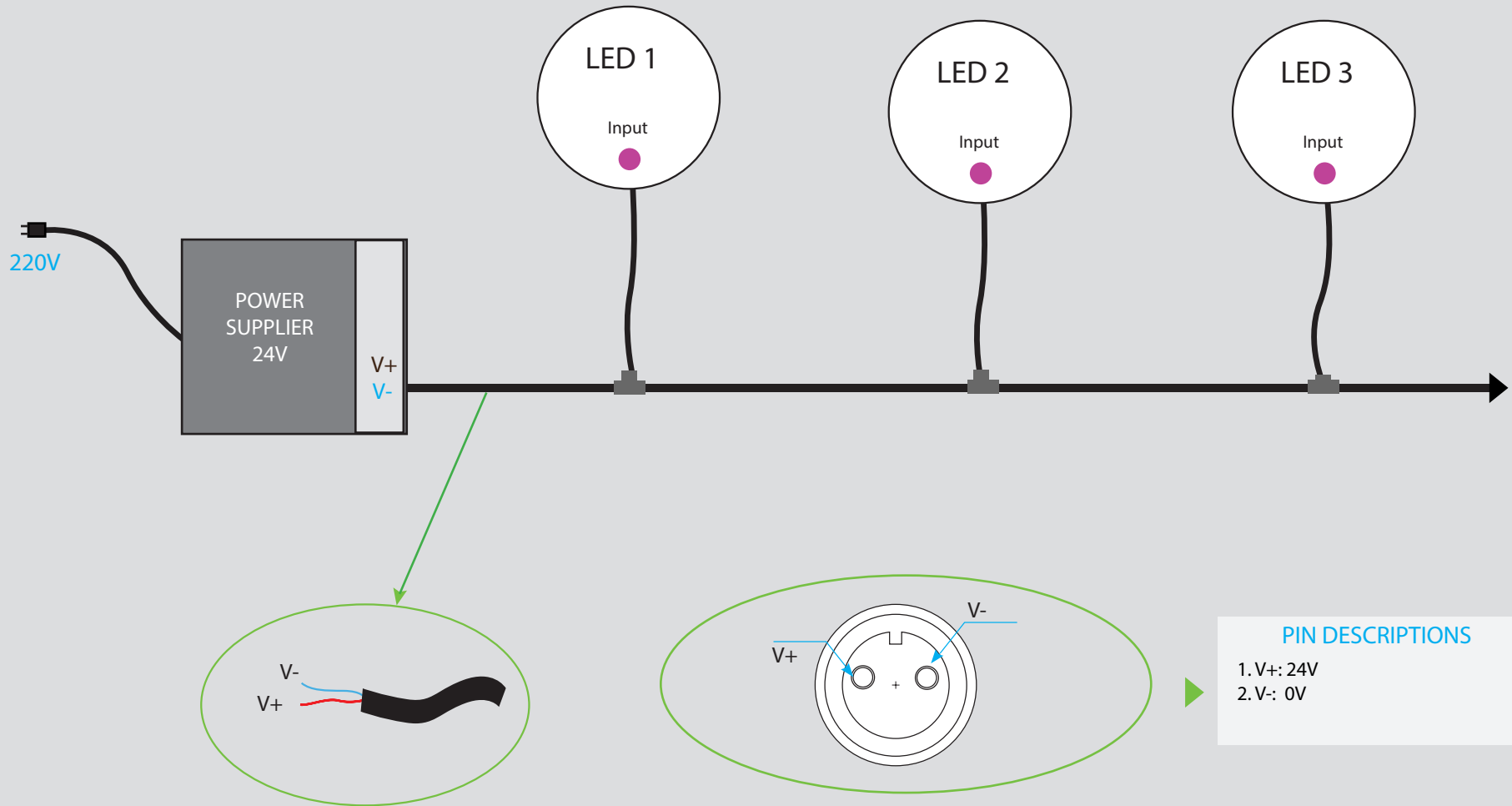

LED WALL LIGHT 2X5W - Applications

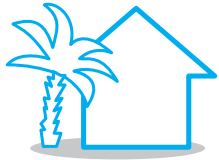

OUTDOOR



LANDSCAPE



HOTEL/RESTAURANT



FACADE BUILDING



LED WALL LIGHT 2X5W - Applications





THANKS FOR YOUR
ATTENTION