



LED SPOTLIGHT 15W - SERIES A  
PRODUCT OUTDOOR



# LED SPOTLIGHT 15W

## SPECCIFICATION



## SPECCIFICATION

- Order Code: SA015
- Input Voltage: 24VDC, 220V
- Dimension: Ø70xL115xH105 mm
- Chip LED: CREE
- Power consumption: 15W
- Luminous Flux: 1350lm at 3000K, 15W, CRI>90, 36°
- Material: Aluminium
- Efficiency: 90%
- Environment temperature: from -30° to 60°C
- Color: 3000K, 4000K, 5000K, RGBW
- CRI: >90
- Beam angle: 12° 24° 36° 50°
- IP Rating: IP68
- Life time: 50.000 hours
- Control: ON/OFF, DIM 0 - 10V, DALI, DMX512
- Standards:
  - + RoHS; EMC protection
  - + IEC 62031LED
  - + IEC 60598 Luminaires



# LED SPOTLIGHT 15W

## TECHNICAL DETAILS

### TECHNICAL DETAILS



### DIMENSIONS

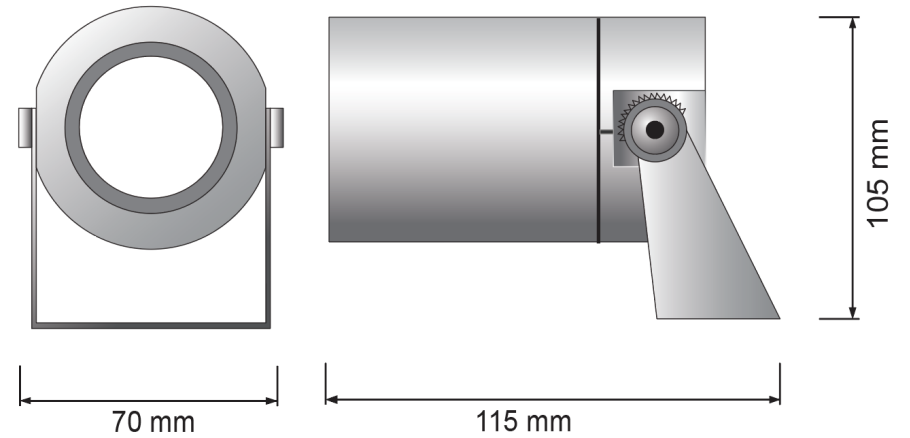

Lens Clear



Legace

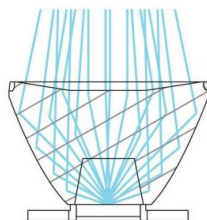

Select Color XX

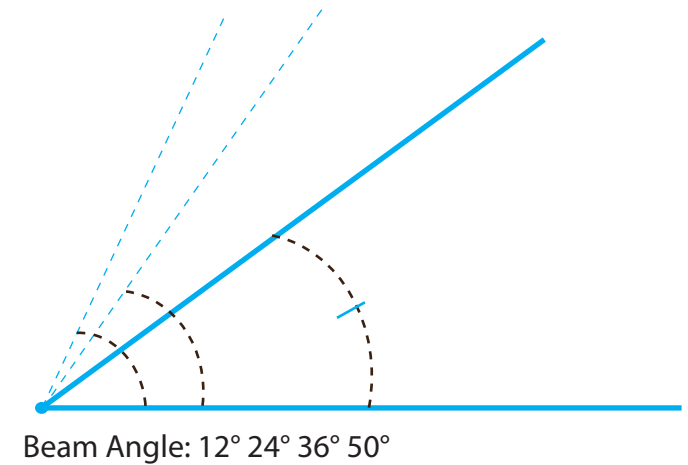
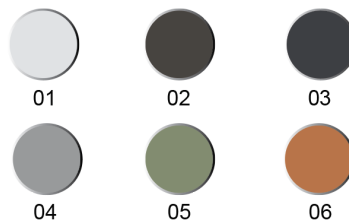

# LED SPOTLIGHT 15W

## SPECIFICATION

### PHOTOMETRIC CURVE BEAM 36° AMPLITUDE DIAGRAM

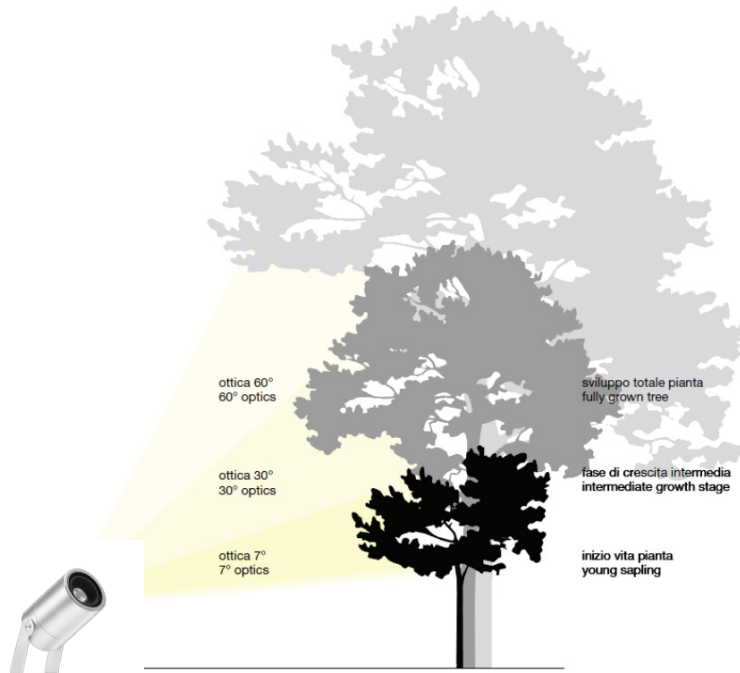
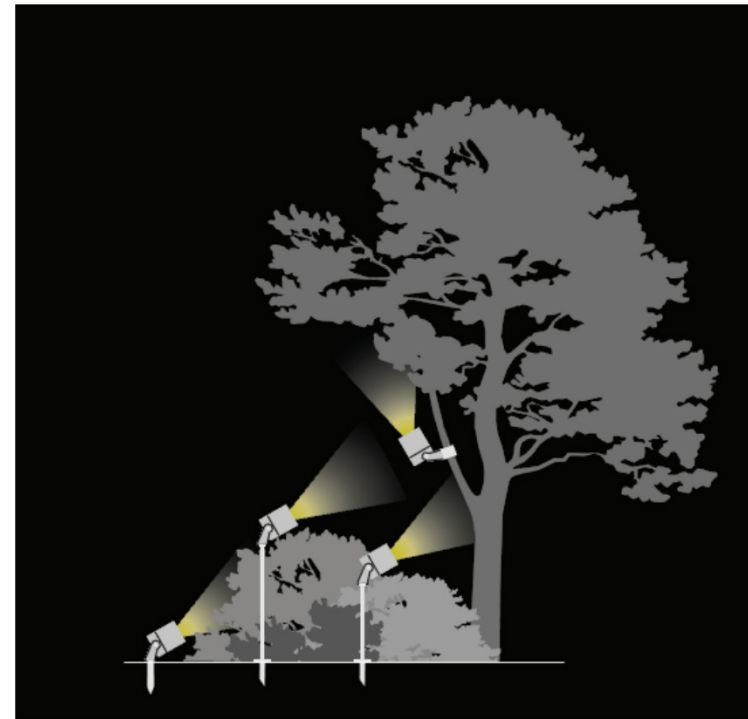
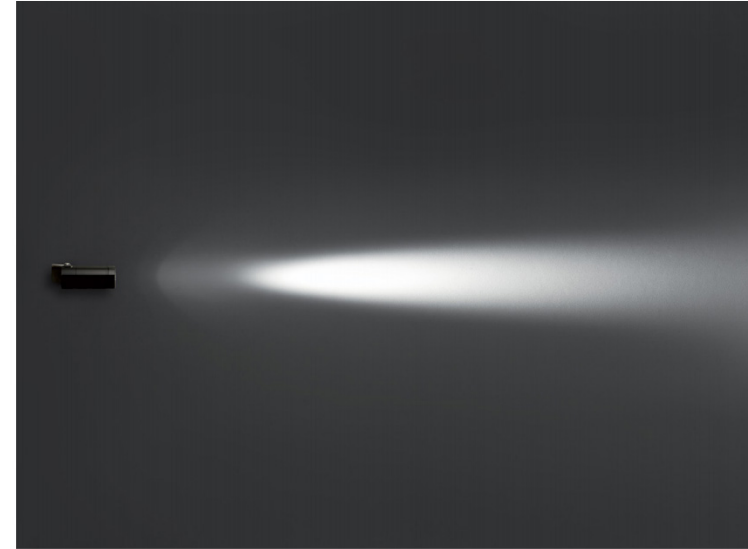
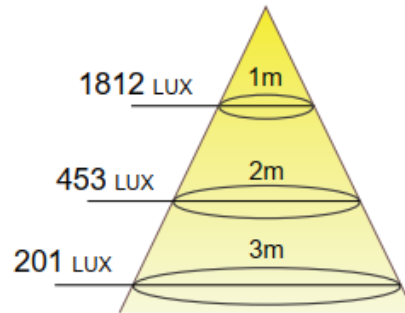
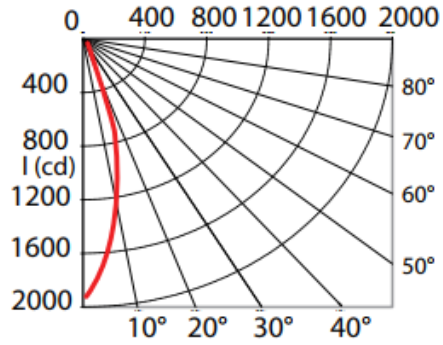

# LED SPOTLIGHT 15W

## POWER SUPPLIES - INPUT VOTAGE

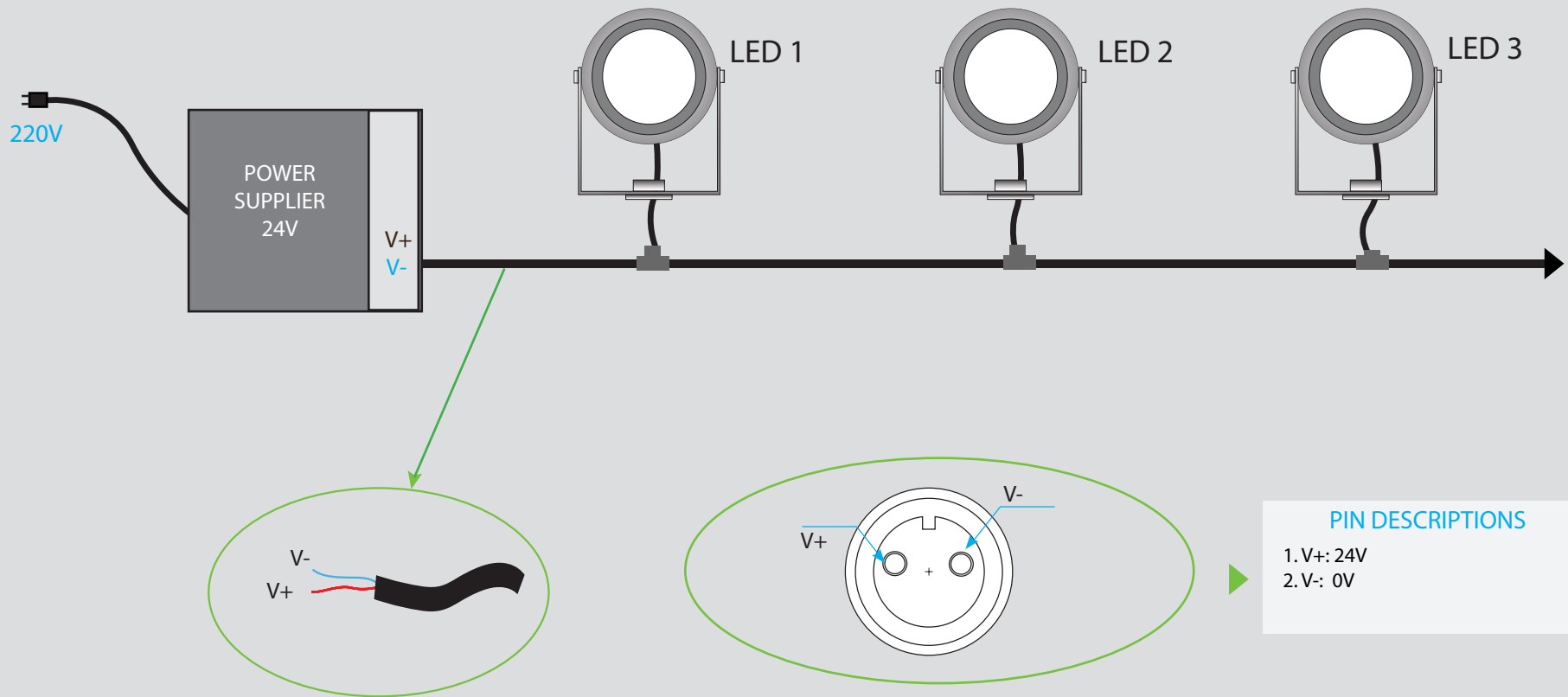

# LED SPOTLIGHT 15W

## DIAGRAM CONNECTOR - DMX PROTOCOL - 4 CORE & DECODER

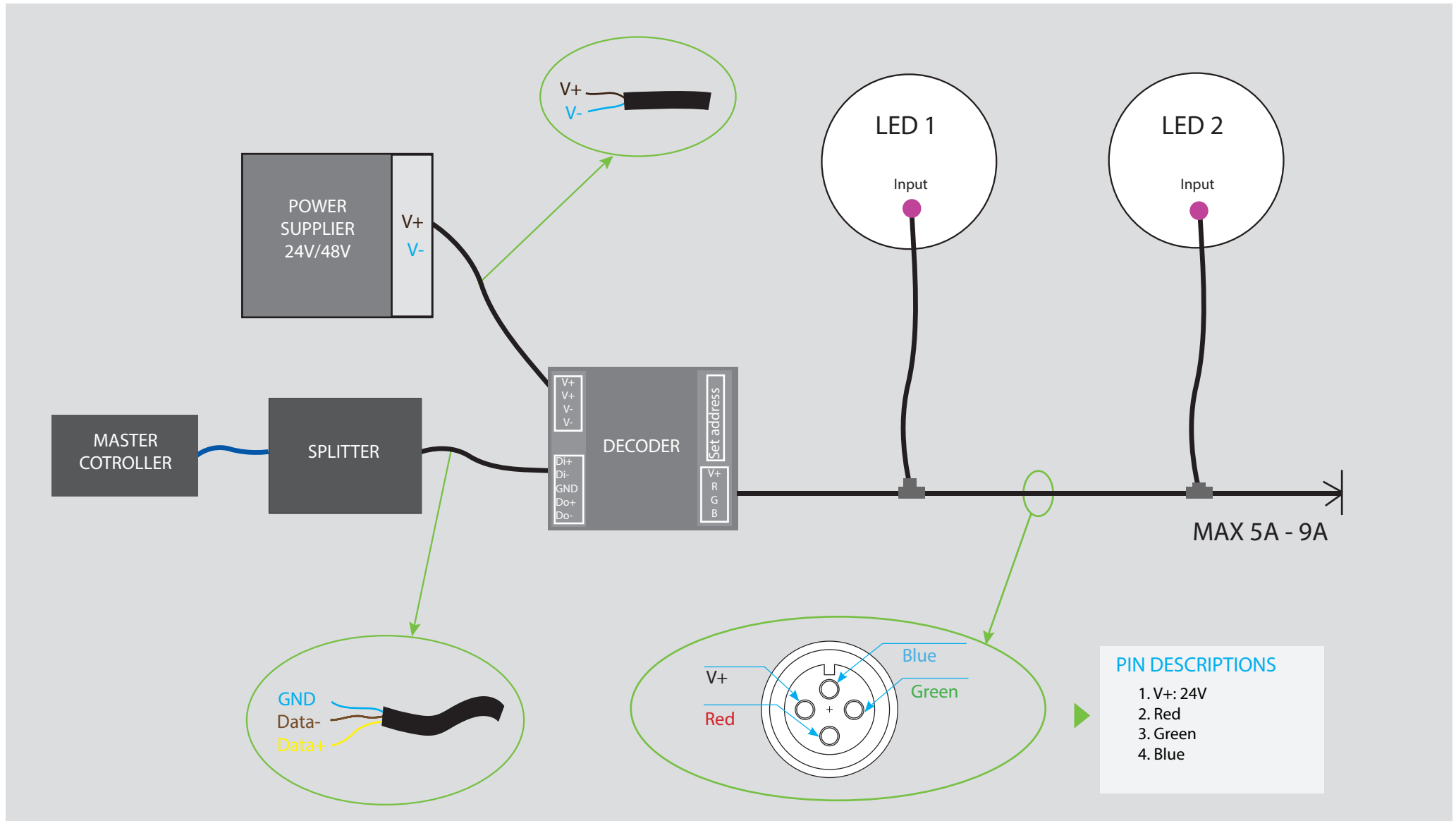

# LED SPOTLIGHT 15W

## DIAGRAM CONNECTOR - DMX PROTOCOL - 5 CORE

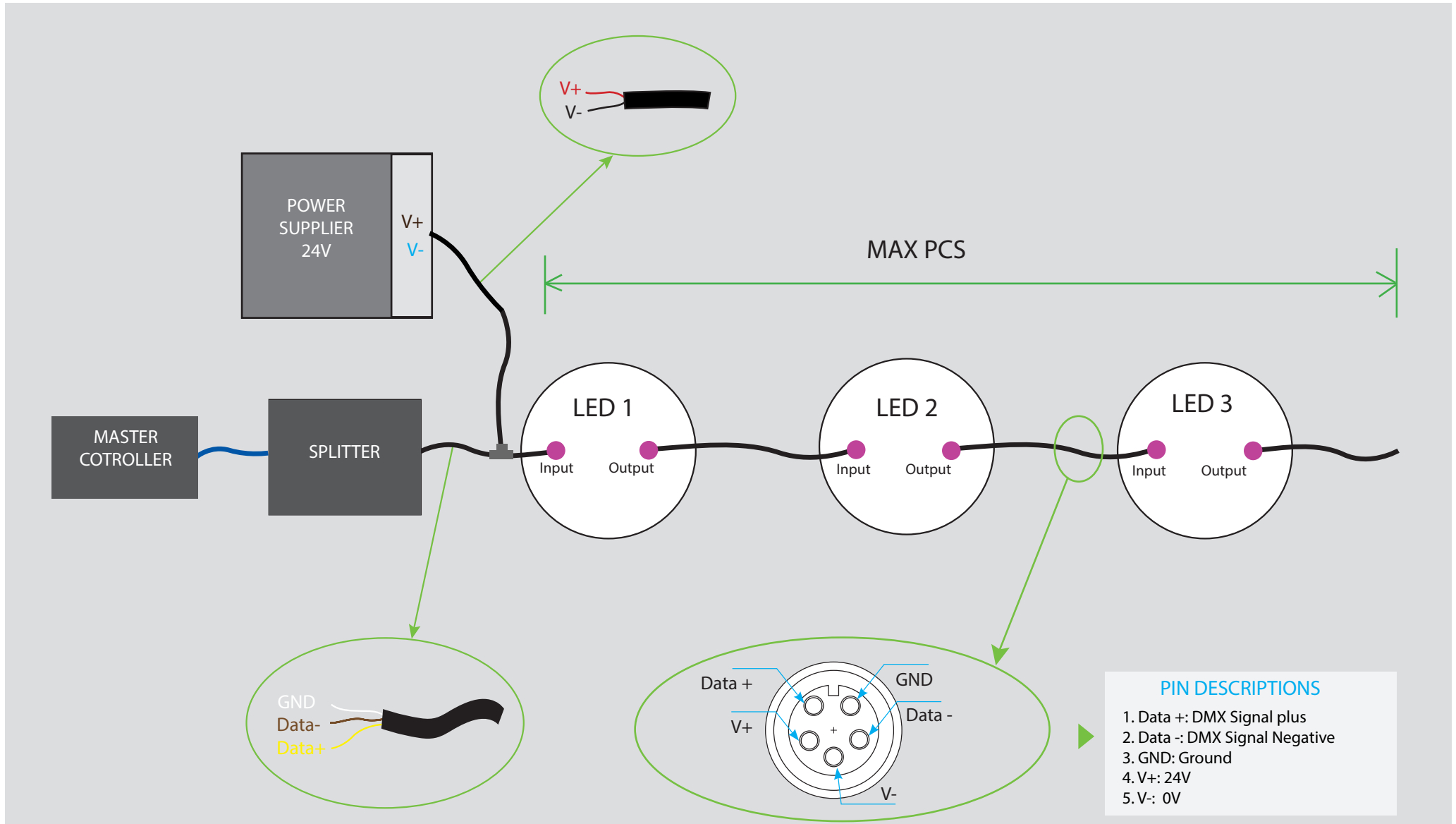

# LED SPOTLIGHT 15W - Applications

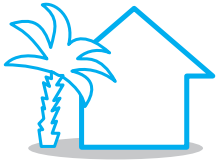

OUTDOOR



LANDSCAPE



HOTEL/RESTAURANT



FACADE BUILDING



# LED SPOTLIGHT 15W - Applications





THANKS FOR YOUR  
ATTENTION