



LED SPOTLIGHT 20W - SERIES A
PRODUCT OUTDOOR



LED SPOTLIGHT 20W

SPECCIFICATION



SPECCIFICATION

- Order Code: SA020
- Input Voltage: 24VDC, 220VAC
- Dimension: Ø84xL170xH117 mm
- Chip LED: CREE
- Power consumption: 20W
- Luminous Flux: 1800Lm at 3000K, 20W, CRI>90, 36°
- Material: Aluminium
- Efficiency: 90%
- Environment temperature: from -30°C to 60°C
- Color: 3000K, 4000K, 5000K, RGBW
- CRI: 90
- Beam angle: 12° 24° 36° 50°
- IP Rating: IP68
- Life time: 50.000 hours
- Control: ON/OFF, DIM 0 - 10V, DALI, DMX512
- Standards:
 - + RoHS; EMC protection
 - + IEC 62031LED
 - + IEC 60598 Luminaires



LED SPOTLIGHT 20W

TECHNICAL DETAILS

TECHNICAL DETAILS



DIMENSIONS

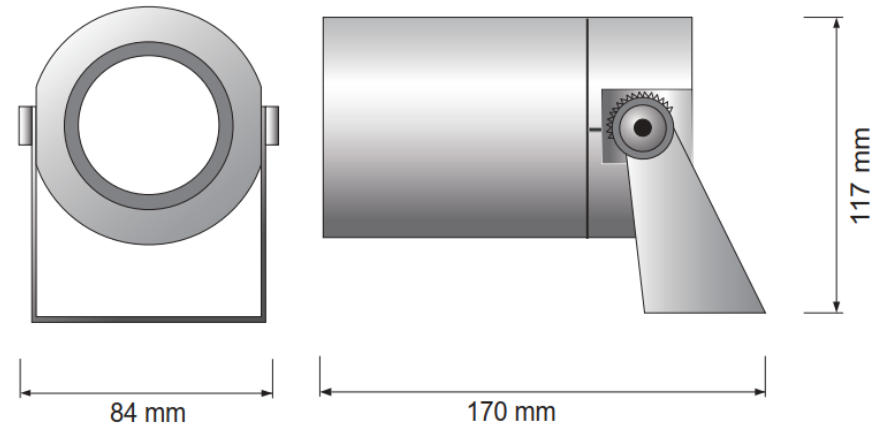

Lens Clear



Legace

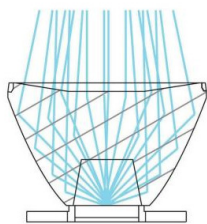

Select Color XX

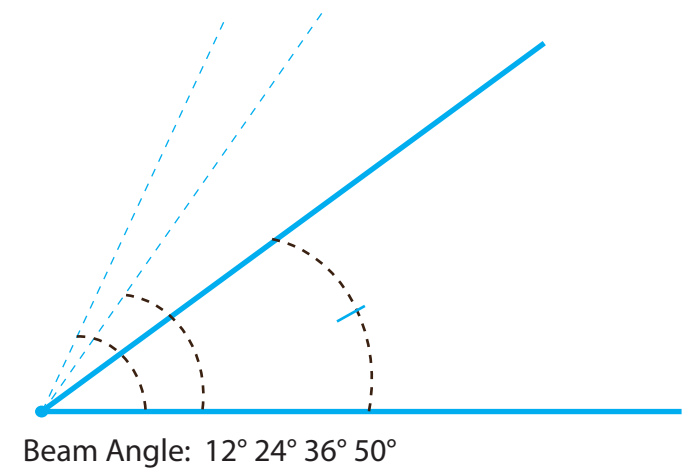
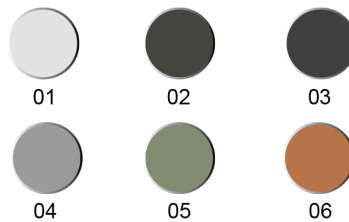

LED SPOTLIGHT 20W

SPECIFICATION

PHOTOMETRIC CURVE BEAM 36° AMPLITUDE DIAGRAM

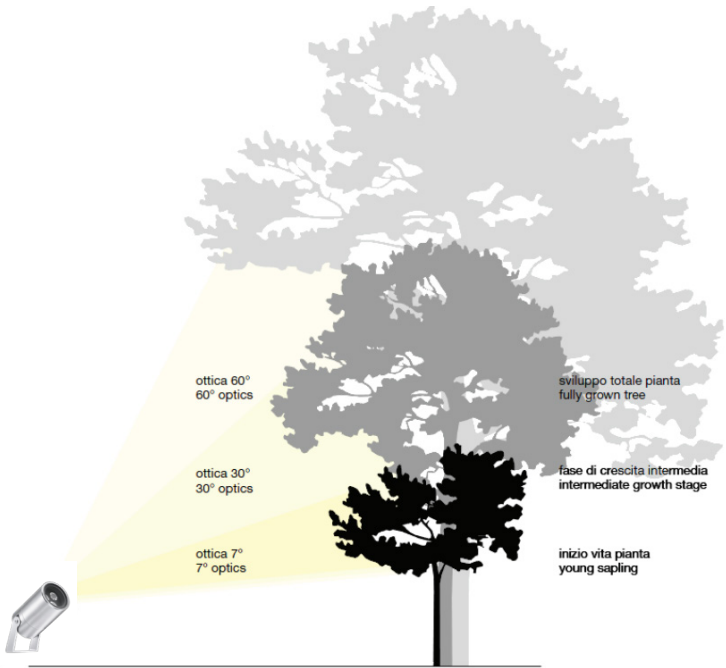
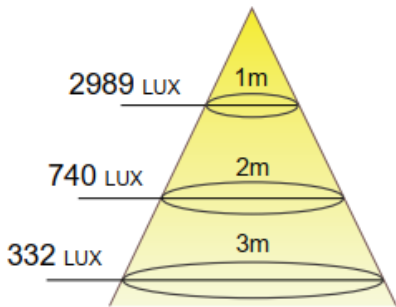
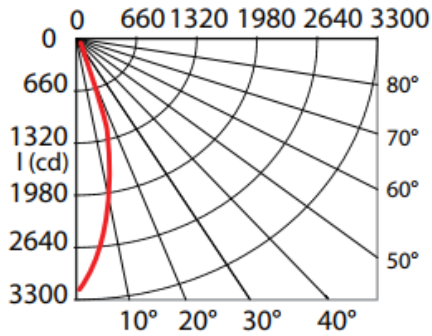

LED SPOTLIGHT 20W

POWER SUPPLIES - INPUT VOTAGE

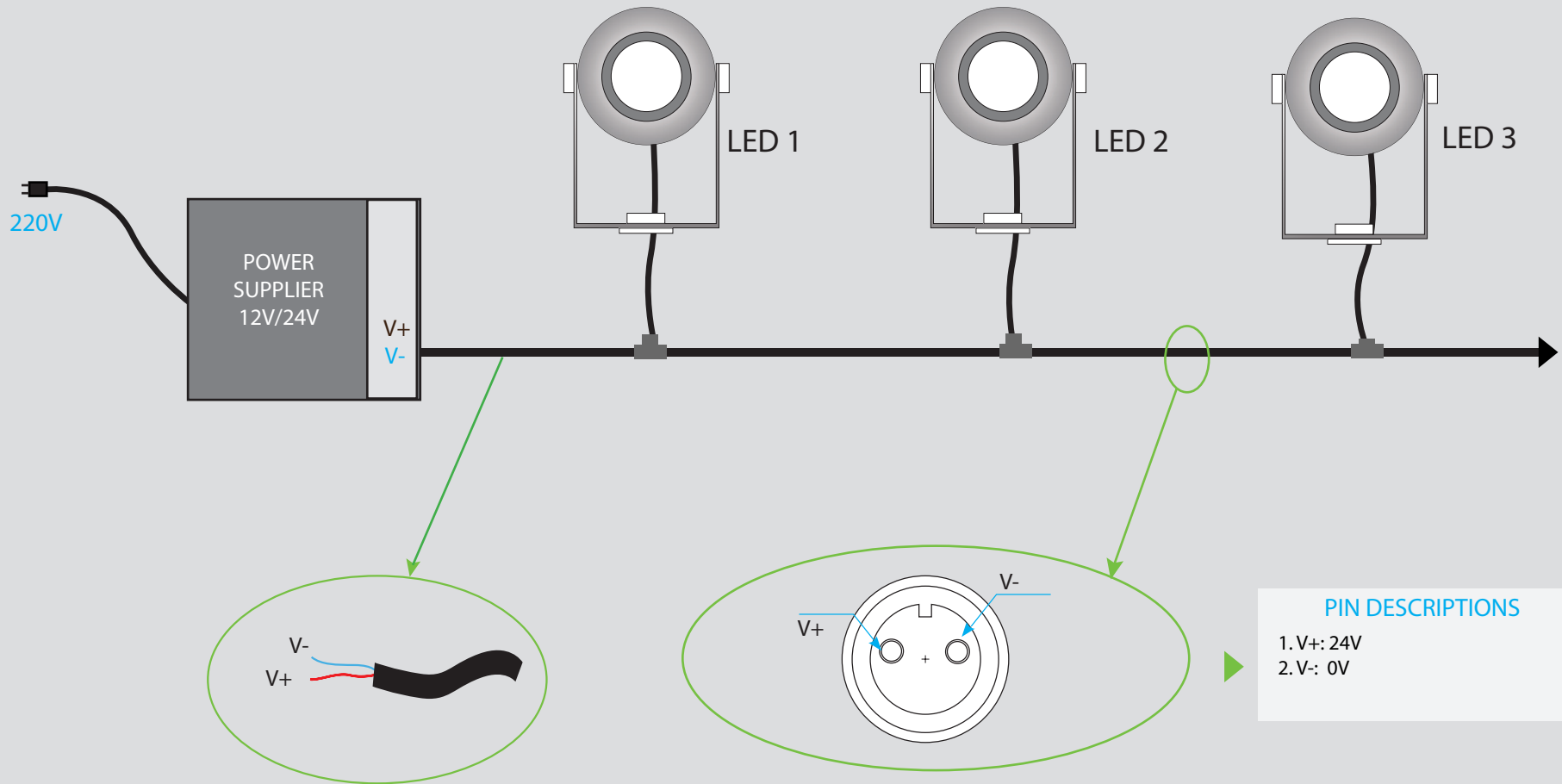

LED SPOTLIGHT 20W

DIAGRAM CONNECTOR - DMX PROTOCOL - 4 CORE & DECODER

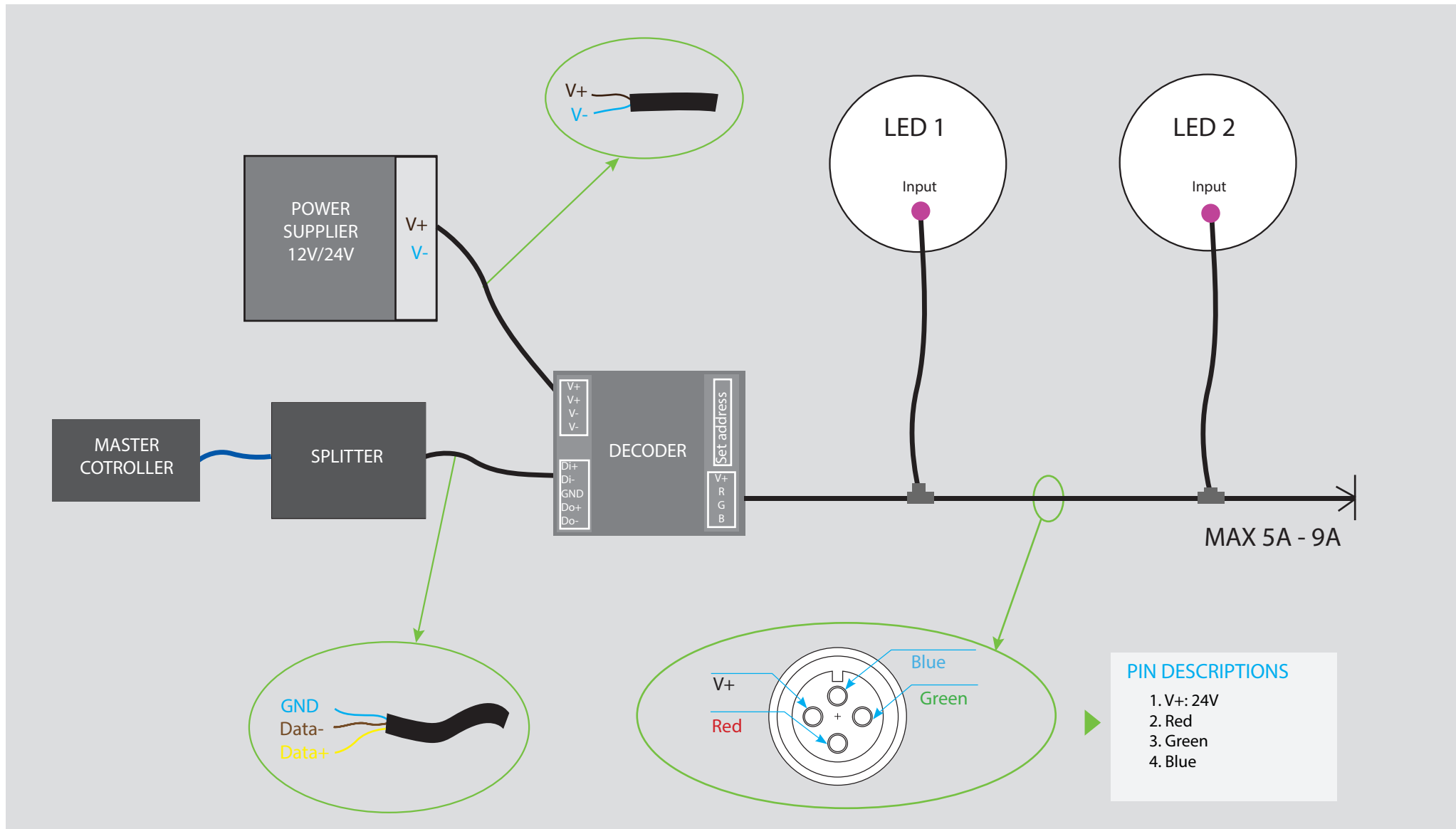

LED SPOTLIGHT 20W

DIAGRAM CONNECTOR - DMX PROTOCOL - 5 CORE

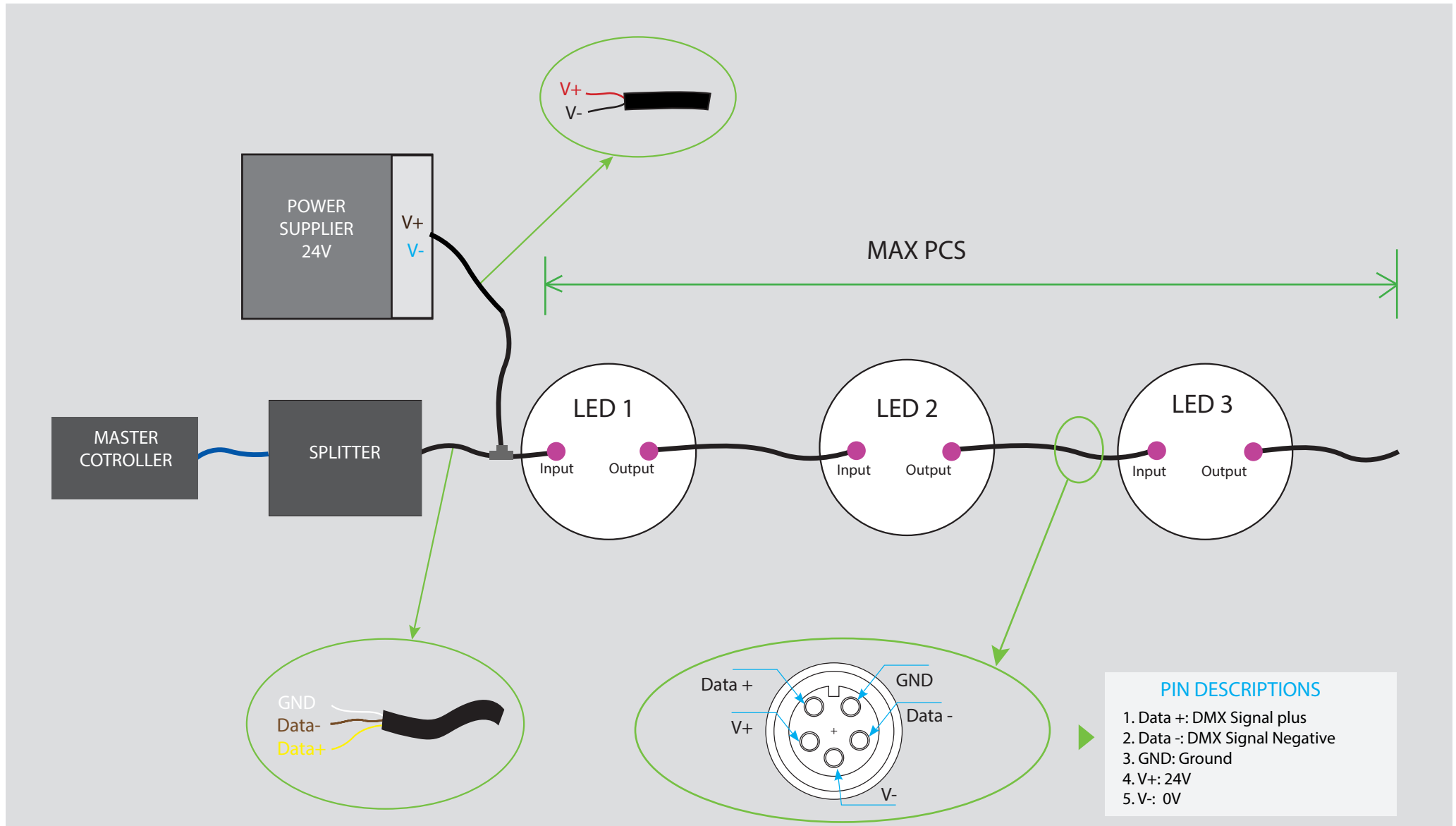

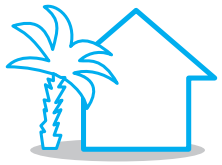

OUTDOOR



LANDSCAPE



HOTEL/RESTAURANT



FACADE BUILDING



LED SPOTLIGHT 20W - Applications





THANKS FOR YOUR
ATTENTION