



LED DOWNLIGHT 8W - SERIES F
PRODUCT INDOOR



LED DOWNLIGHT 8W

SPECIFICATION



SPECIFICATION

- Order Code: DF008
- Input Voltage: 24Vdc, 220Vac, Dimmable
- Dimension: Ø110xH65 Cutout Ø90mm
- Chip LED: CREE
- Power consumption: 8W
- Luminous Flux: 720Lm at 3000K, 8W, CRI>90, 36°
- Material: Aluminium
- Efficiency: 90%
- Environment temperature: from -30° to 60°C
- Color: 3000K, 4000K, 5000K
- CRI: >90
- Beam angle: 12° 25° 36° 50°
- IP Rating: IP44 (Update IP67)
- Life time: 50.000 hours
- Control: ON/OFF, 0 - 10V, DALI, DMX
- Standards:
 - + RoHS; EMC protection
 - + IEC 62031LED
 - + IEC 60598 Luminaires



LED DOWNLIGHT 8W

TECHNICAL DETAILS

TECHNICAL DETAILS

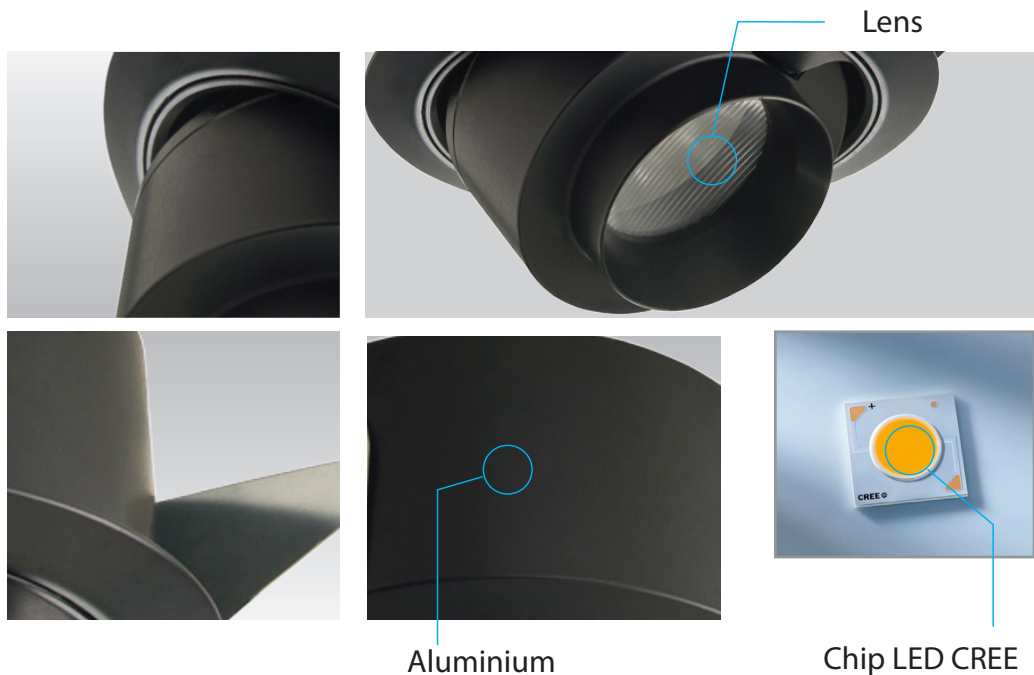

Legace

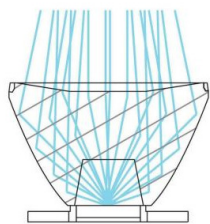

Select Color XX

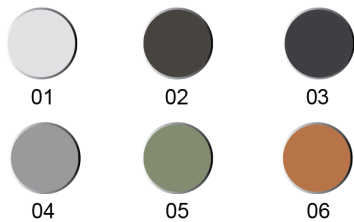

DIMENSIONS

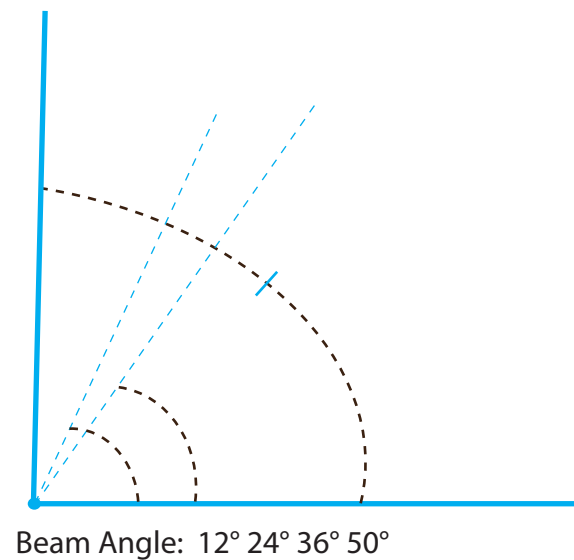
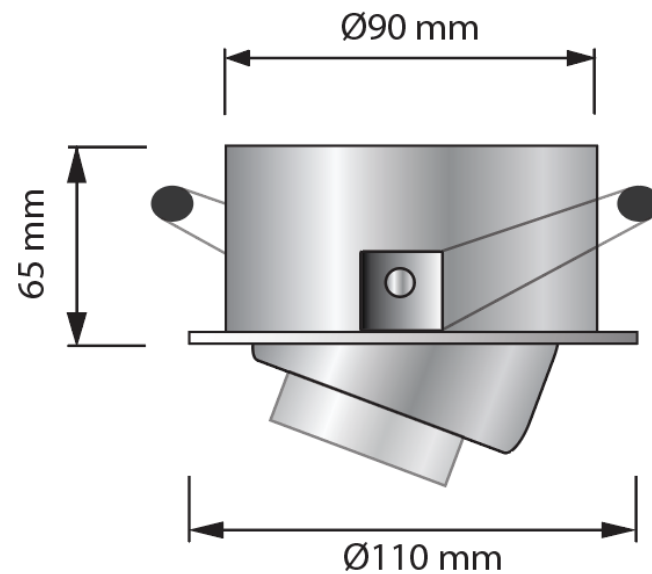

LED DOWNLIGHT 8W

SPECIFICATION

8W 3000K

PHOTOMETRIC CURVE BEAM 36° AMPLITUDE DIAGRAM

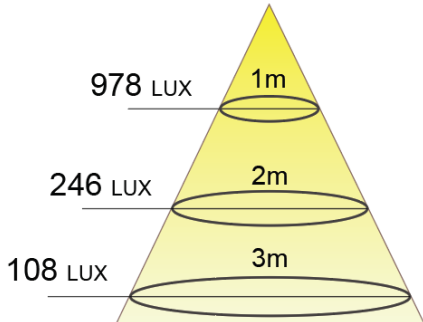
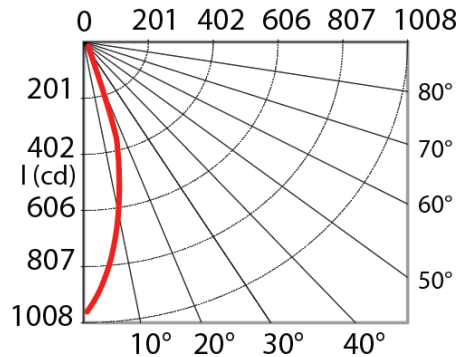

INSTALLATION

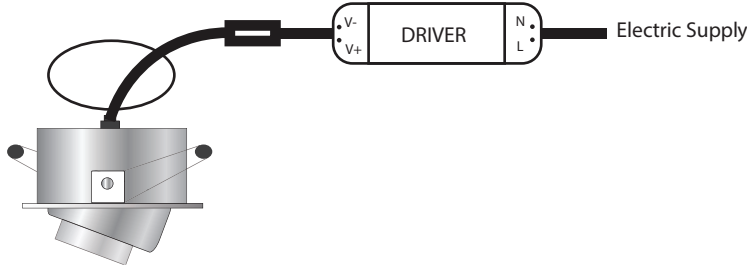

LED DOWNLIGHT 8W- Applications



INDOOR



OFFICE



HOTEL/RESTAURANT



LED DOWNLIGHT 8W - Applications





THANKS FOR YOUR
ATTENTION