



LED UNDER WATER LIGHT 5W - SERIES B
PRODUCT OUTDOOR



LED UNDER WATER LIGHT 5W

SPECCIFICATION



SPECCIFICATION

- Order Code: UB005
- Input Voltage: 24VDC
- Dimension: Ø40xL70xH75 mm
- Chip LED: CREE
- Power consumption: 5W
- Luminous Flux: 450lm at 3000K, 5W, CRI>90, 36°
- Material: Stainless steel
- Efficiency: 90%
- Environment temperature: from -30° to 60°C
- Color: 3000K, 4000K, 5000K
- CRI: >90
- Beam angle: 12° 15° 24° 36° 50°
- IP Rating: IP68
- Life time: 50.000 hour
- Control: ON/OFF
- Standards:
 - + RoHS; EMC protection
 - + IEC 62031LED
 - + IEC 60598 Luminaires



LED UNDER WATER LIGHT 5W

TECHNICAL DETAILS

TECHNICAL DETAILS



Lens clear



Stainless Steel



Chip LED CREE

Legace Reflektor

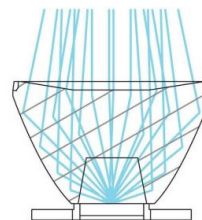

Connector IP68



Lens Clear



DIMENSIONS

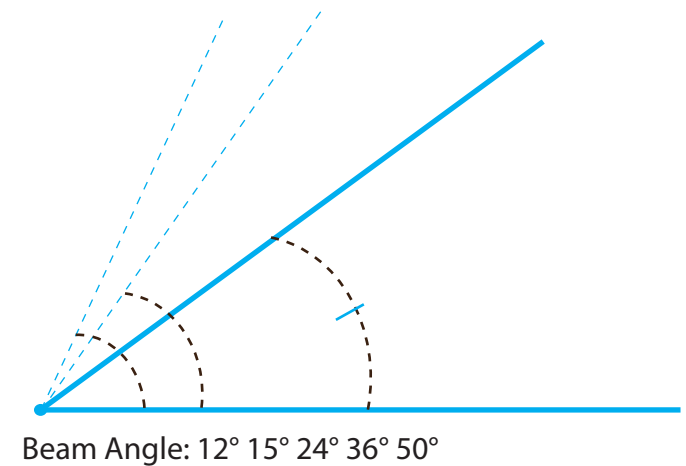
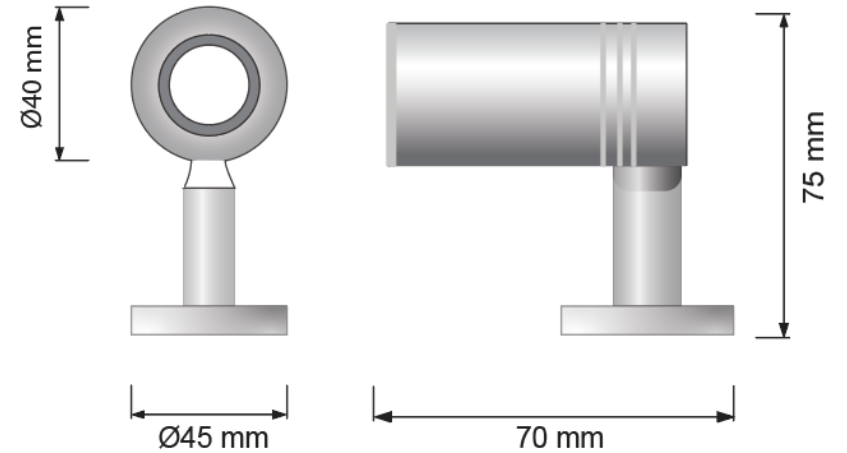

LED UNDER WATER LIGHT 5W

SPECIFICATION

PHOTOMETRIC CURVE

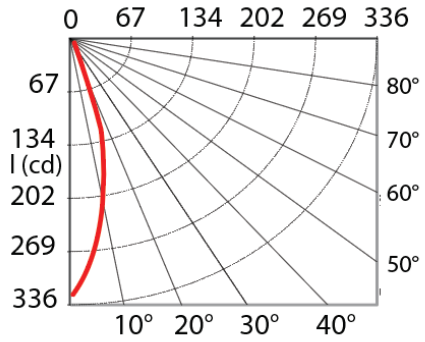

BEAM 36° AMPLITUDE DIAGRAM

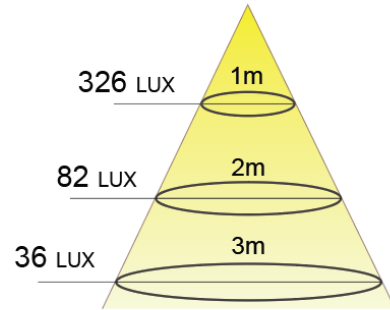

OPTICS

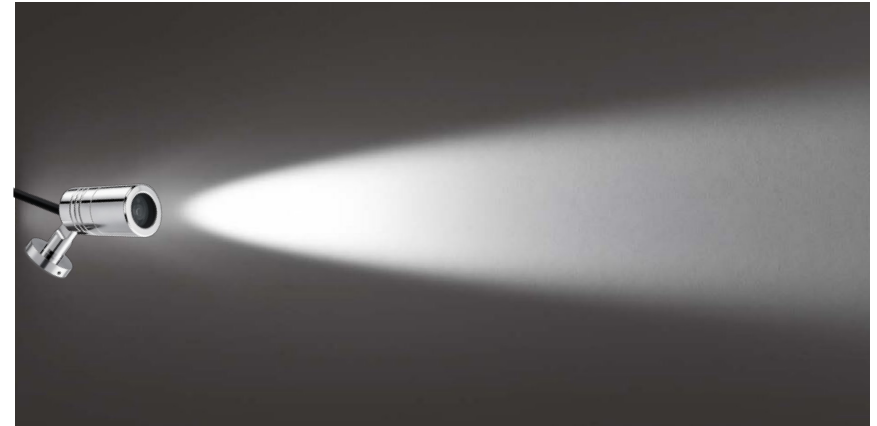

INSTALLATION

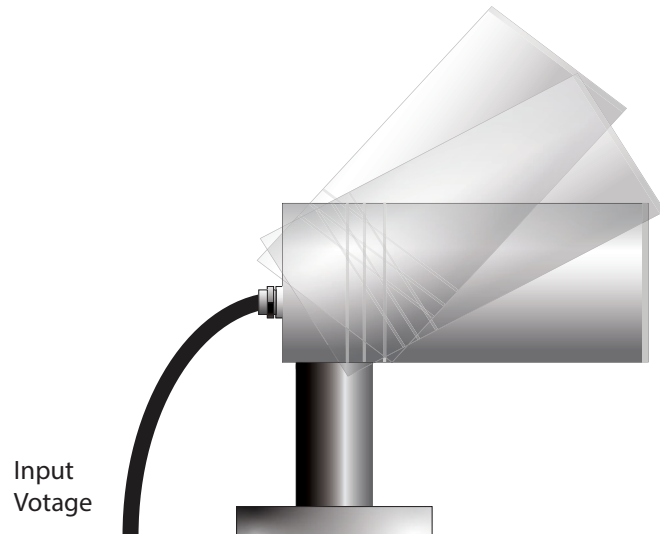

CONNECTOR IP68

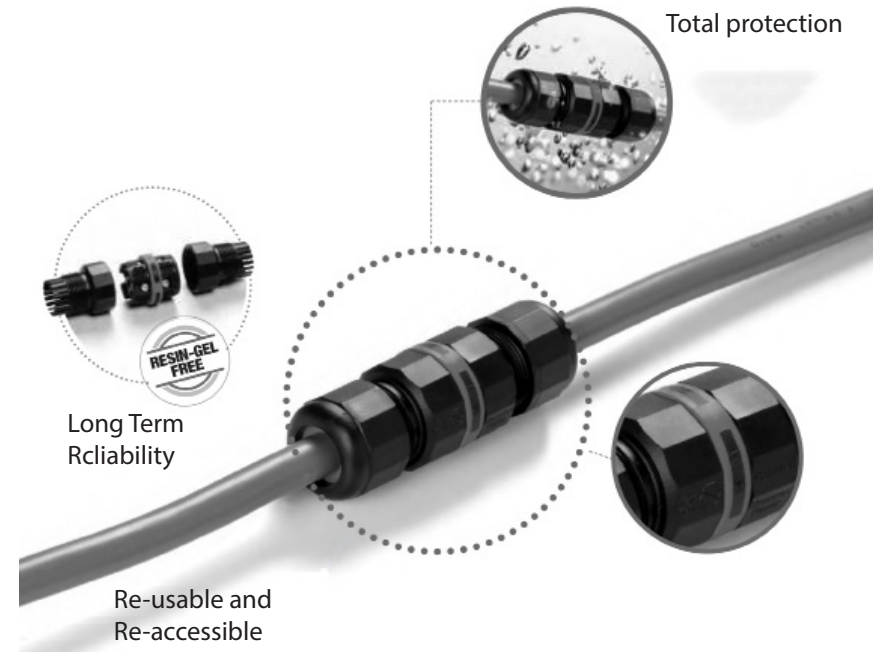

LED UNDER WATER LIGHT 5W

POWER SUPPLIES - INPUT VOTAGE

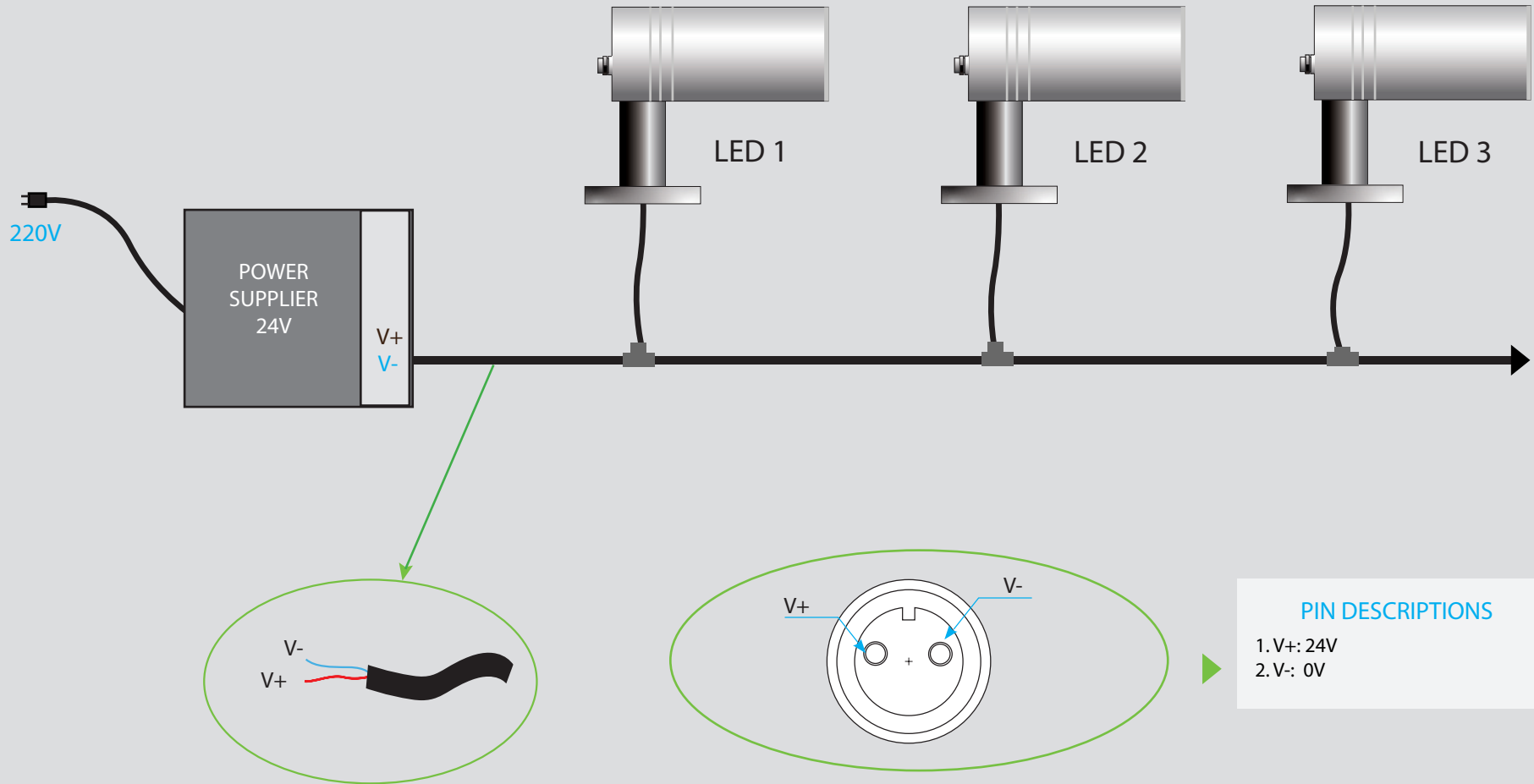

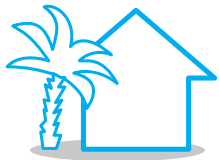

OUTDOOR



LANDSCAPE

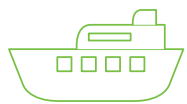

LED UNDER WATER LIGHT 5W - Applications





THANKS FOR YOUR
ATTENTION