



LED DOWNLIGHT 20W - SERIES I2
PRODUCT INDOOR & OUTDOOR



LED DOWNLIGHT 20W

SPECIFICATION



SPECIFICATION

- Order Code: DI2020
- Input Voltage: 24Vdc, 220Vac, Dimmable
- Dimension: L120xW120xH120 mm
- Chip LED: CREE
- Power consumption: 20W
- Luminous Flux: 1800Lm at 3000K, 20W, CRI>90, 36°
- Material: Aluminium
- Efficiency: 90%
- Environment temperature: from -30° to 60°C
- Color[CRI]: 3000K, 4000K, 5000K
- CRI: >90
- Beam angle: 12° 25° 36° 50°
- IP Rating: IP65
- Life time: 50.000 hours
- Control: ON/OFF, 0 - 10V, DALI, DMX
- Standards:
 - + RoHS; EMC protection
 - + IEC 62031LED
 - + IEC 60598 Luminaires



LED DOWNLIGHT 20W

TECHNICAL DETAILS

TECHNICAL DETAILS

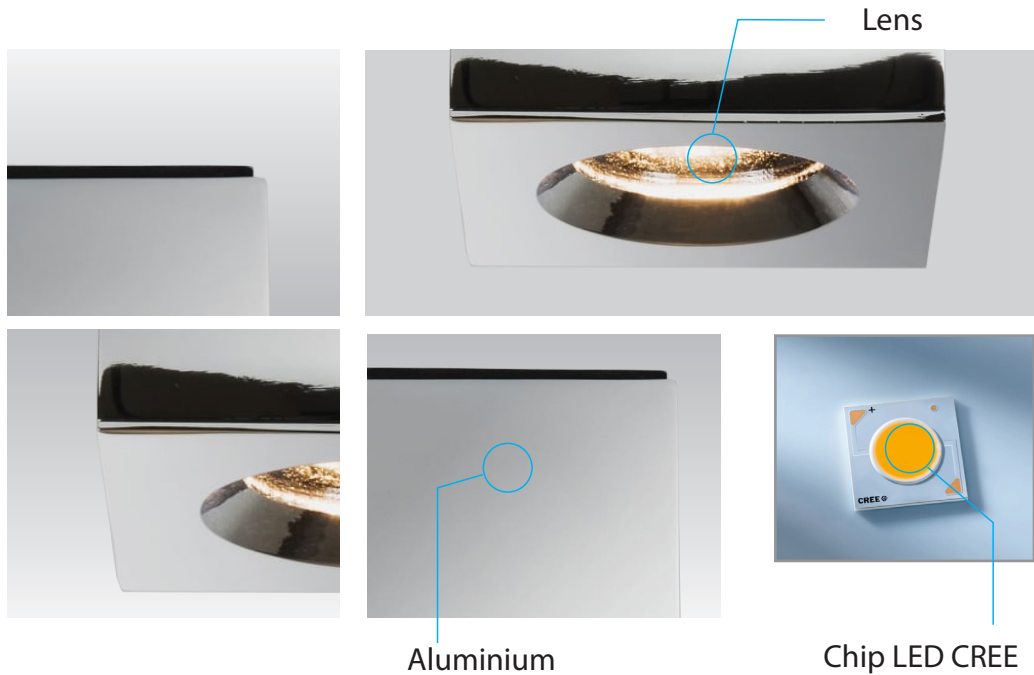

Legace

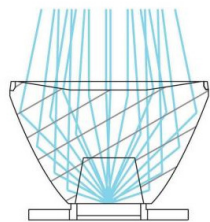

Select Color XX

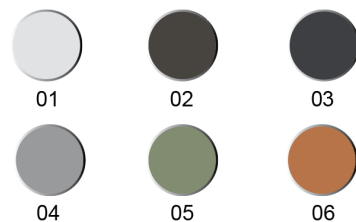

DIMENSIONS

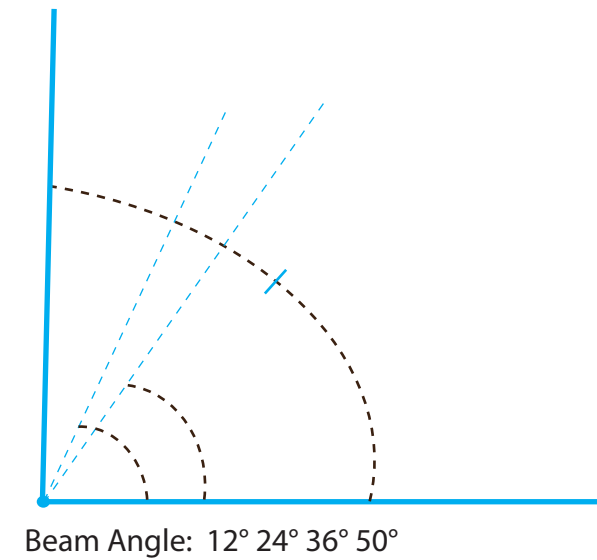
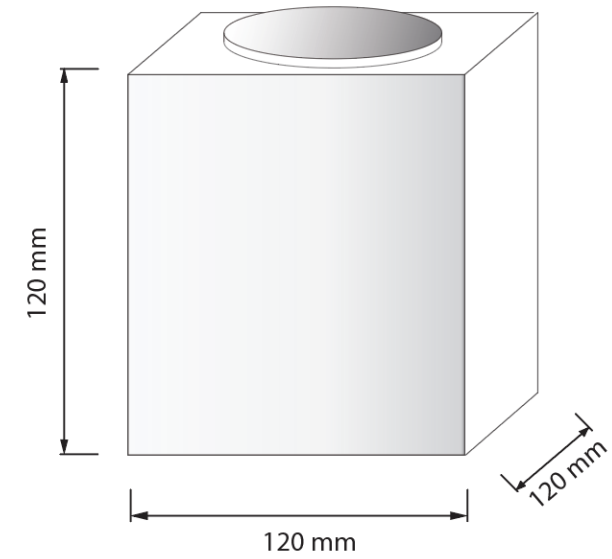

LED DOWNLIGHT 20W

SPECIFICATION

PHOTOMETRIC CURVE BEAM 36° AMPLITUDE DIAGRAM

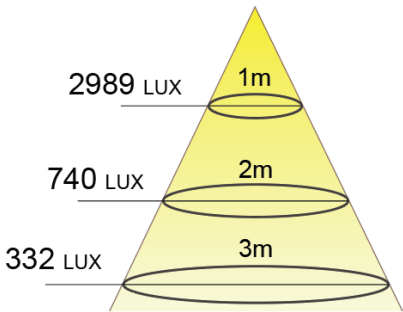
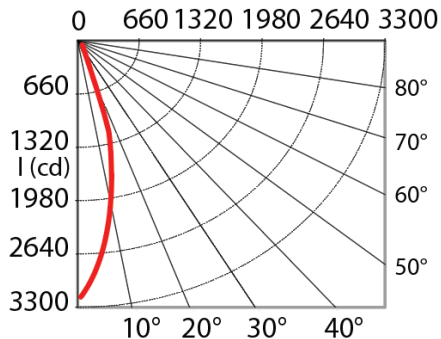

INSTALLATION

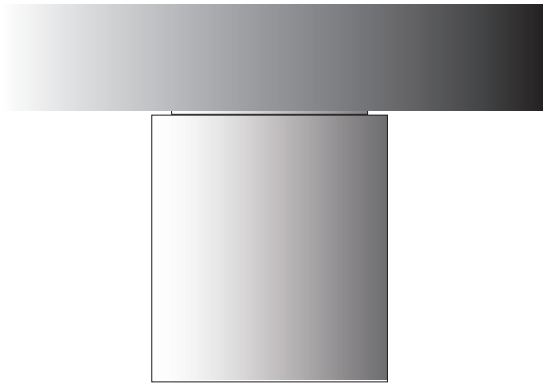



INDOOR



OFFICE



HOTEL/RESTAURANT



LED DOWNLIGHT 20W - Applications





THANKS FOR YOUR
ATTENTION