



LED INGROUND LIGHT 9W - SERIES A
PRODUCT OUTDOOR



LED INGROUND LIGHT 9W

02

SPECCIFICATION

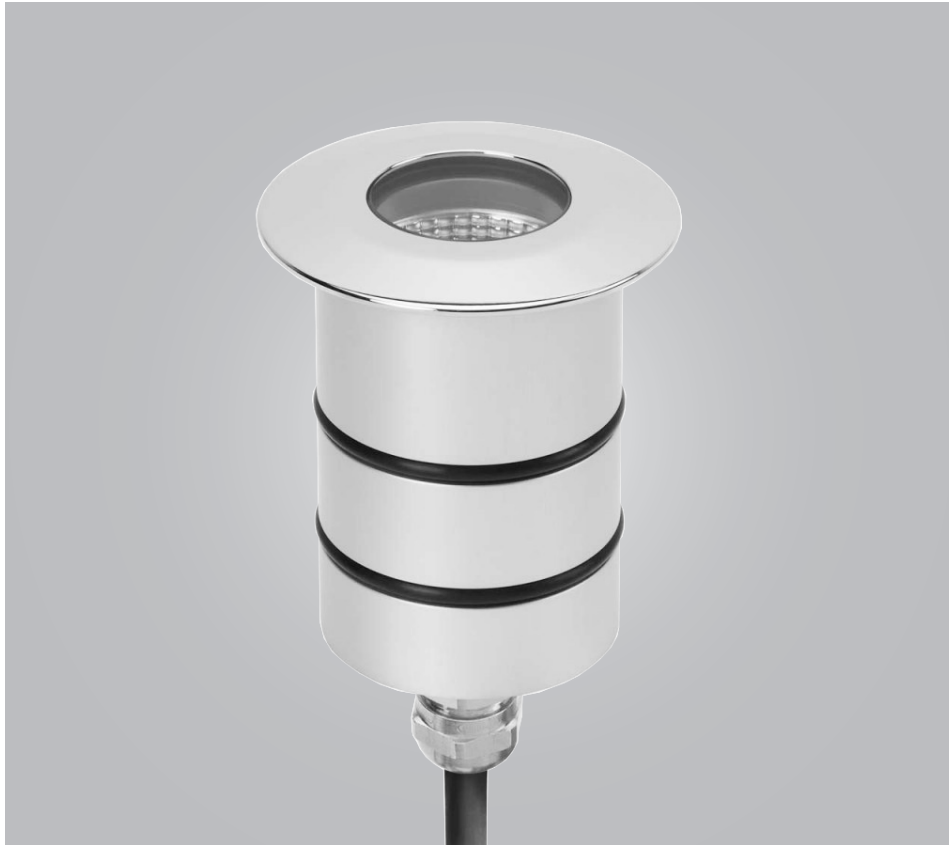

SPECCIFICATION

- Order Code: IA009, IA009RGBW
- Input Voltage: 24VDC, 220V
- Dimension: Ø60xH103 Cutout Ø50 mm
- Chip LED: CREE
- Power consumption: 9W
- Lumen Output: 810 lm
- Material: Aluminium
- Efficiency: 90%
- Environment temperature: from -30° to 60°C
- Color[CRI]: 3000K, 4000k, 5000k, RGBW
- CRI: >90
- Beam angle: 12° 24° 36° 50°
- IP Rating: IP68
- Life time: 50.000 hour
- Control: ON/OFF, DIM 0 - 10V, DALI, DMX512
- Standards:
 - + RoHS; EMC protection
 - + IEC 62031LED
 - + IEC 60598 Luminaires



LED INGROUND LIGHT 9W

TECHNICAL DETAILS

TECHNICAL DETAILS

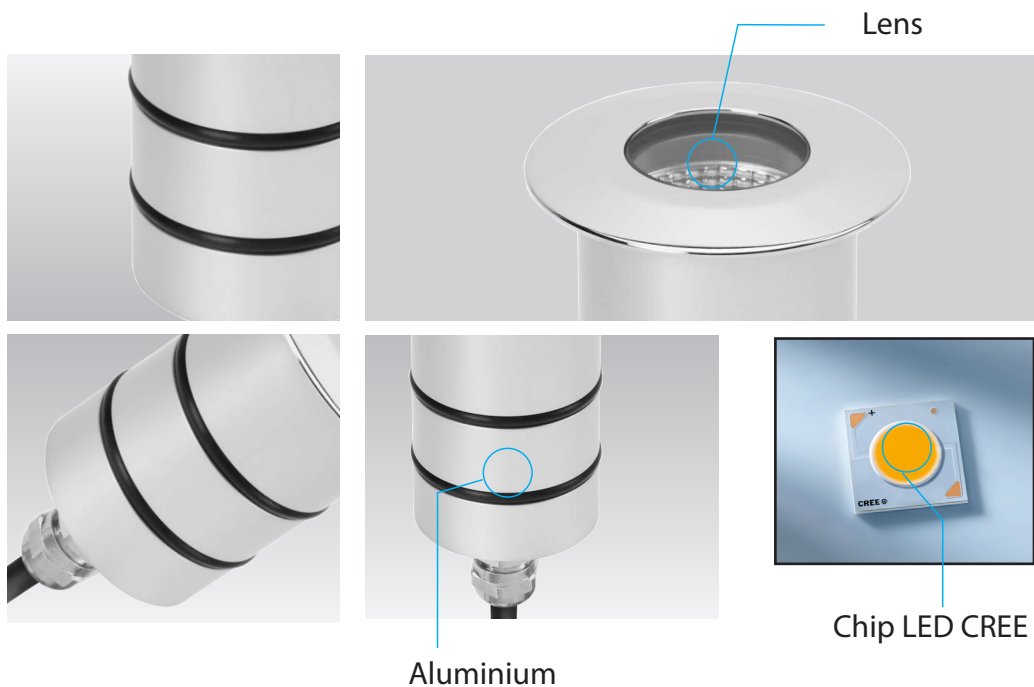

Connector IP68



Lens Clear



Legace Reflektor

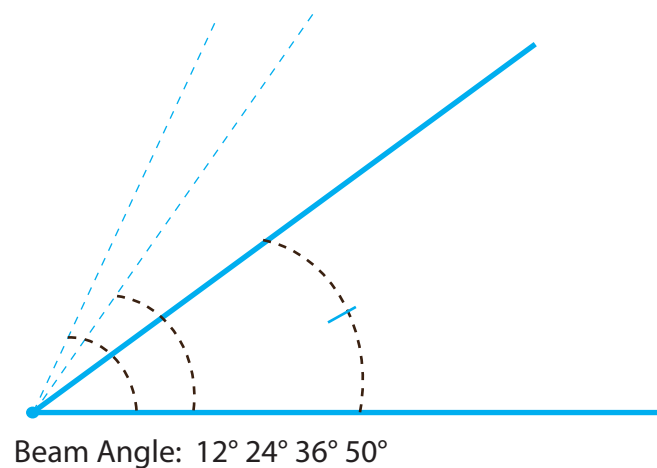
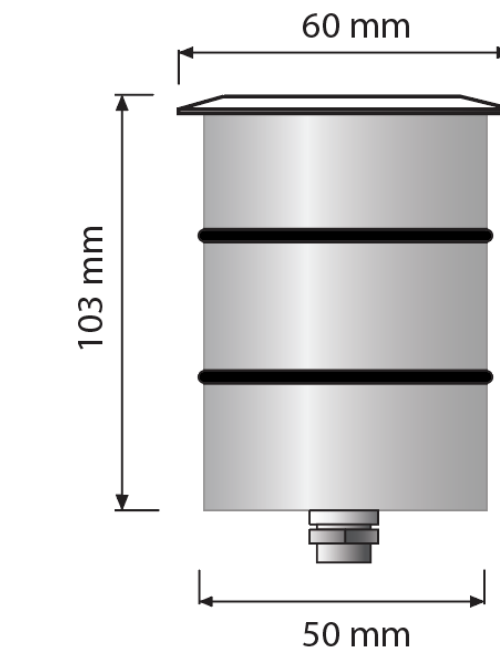
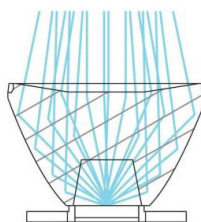

LED INGROUND LIGHT 9W

SPECIFICATION

36° Beam Angle

PHOTOMETRIC CURVE

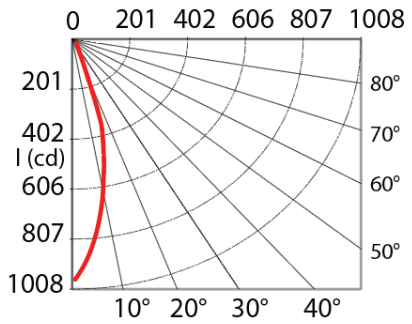

BEAM 36° AMPLITUDE DIAGRAM

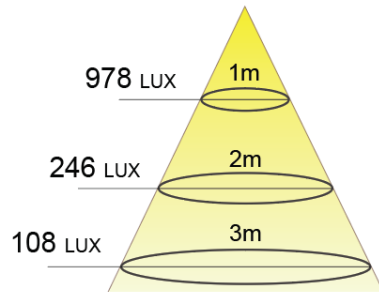

INSTALLATION

Option 1

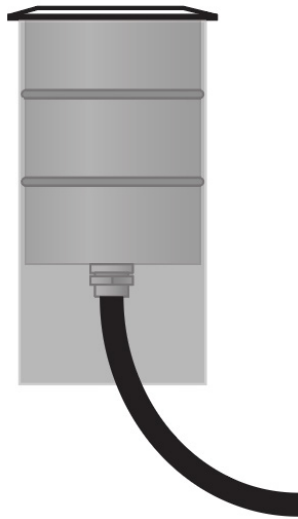

Option 2

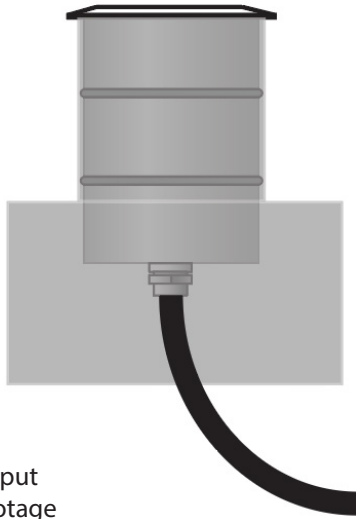

Input Voltage

Input Voltage

CONNECTOR IP68

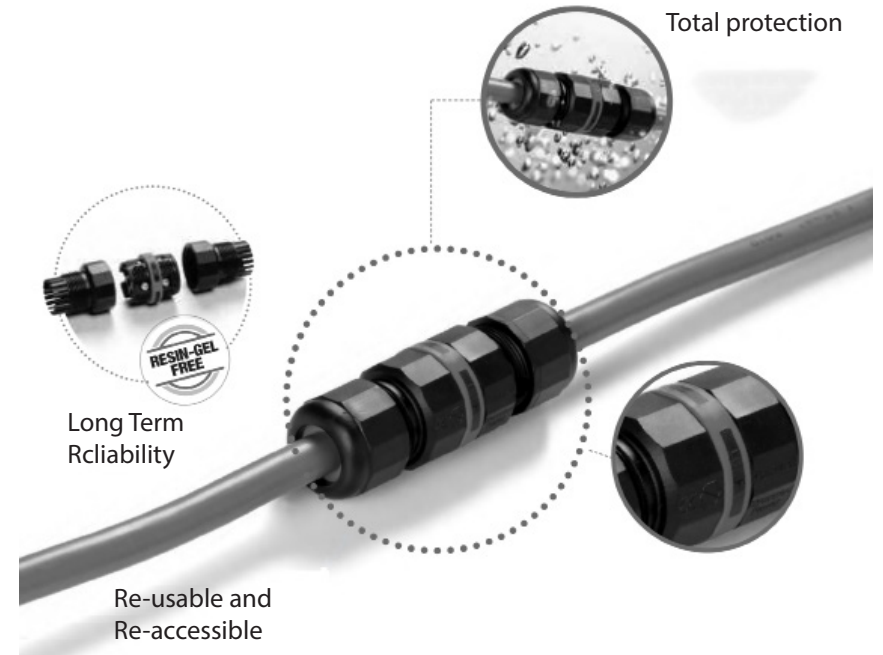

LED INGROUND LIGHT 9W

POWER SUPPLIES - INPUT VOTAGE

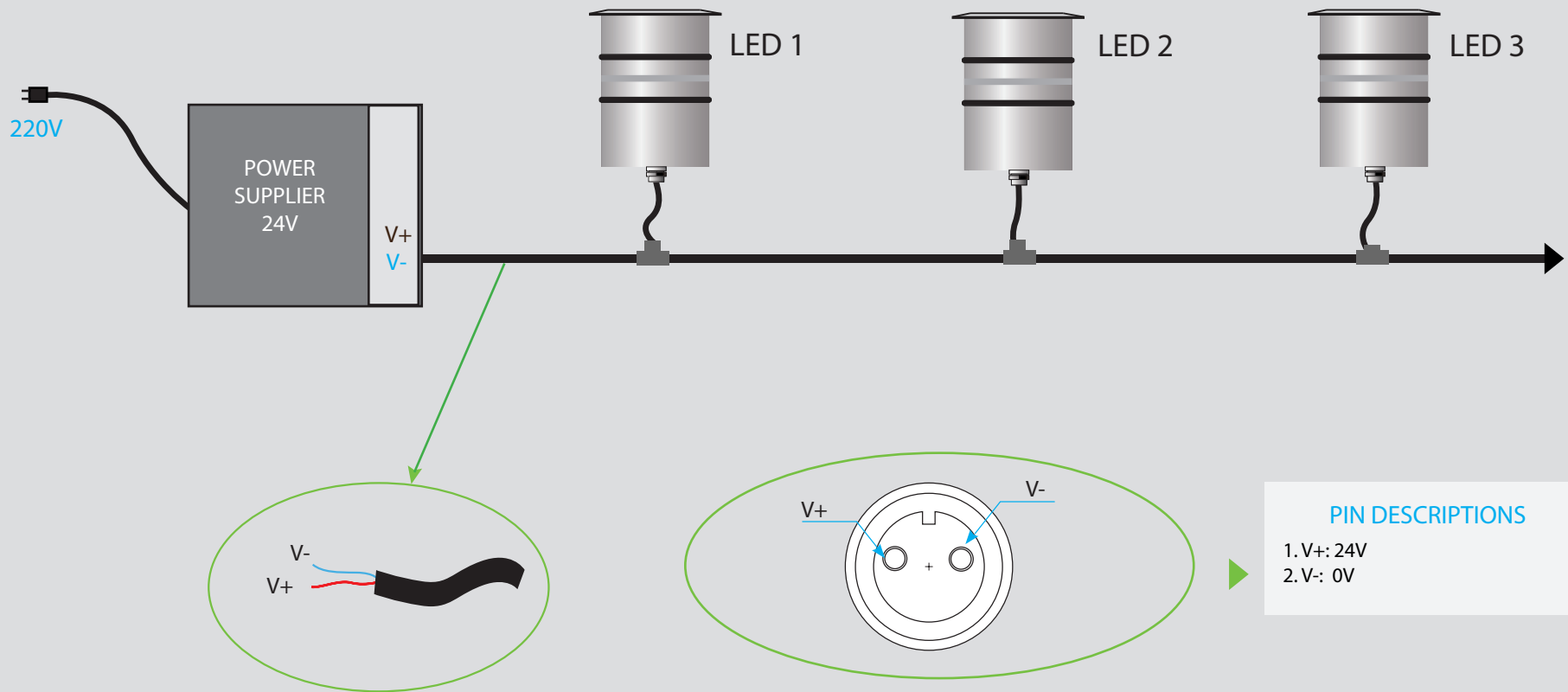

LED INGROUND LIGHT 9W

DIAGRAM CONNECTOR - DMX PROTOCOL - 4 CORE & DECODER

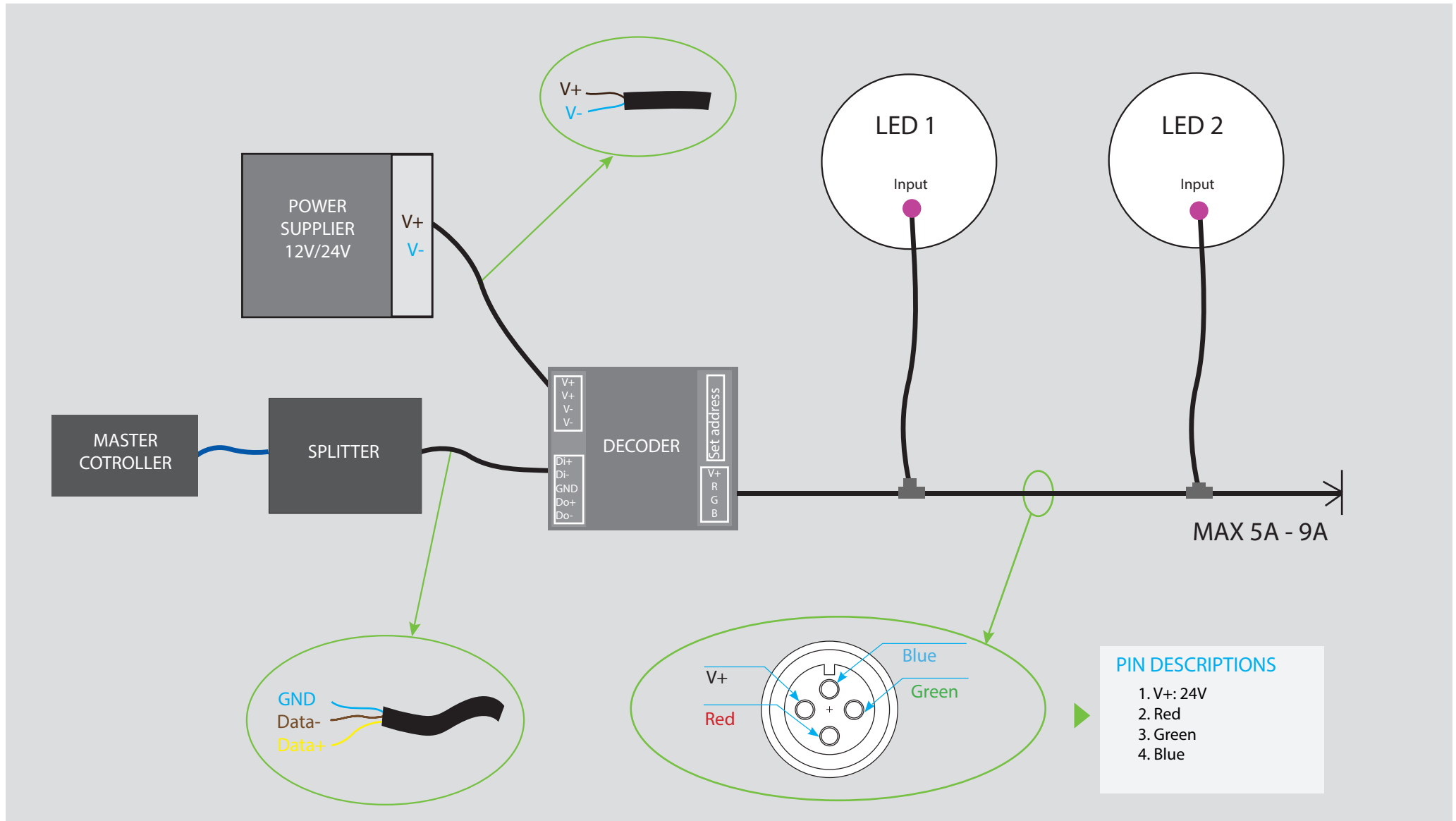

LED INGROUND LIGHT 9W

DIAGRAM CONNECTOR - DMX PROTOCOL - 5 CORE

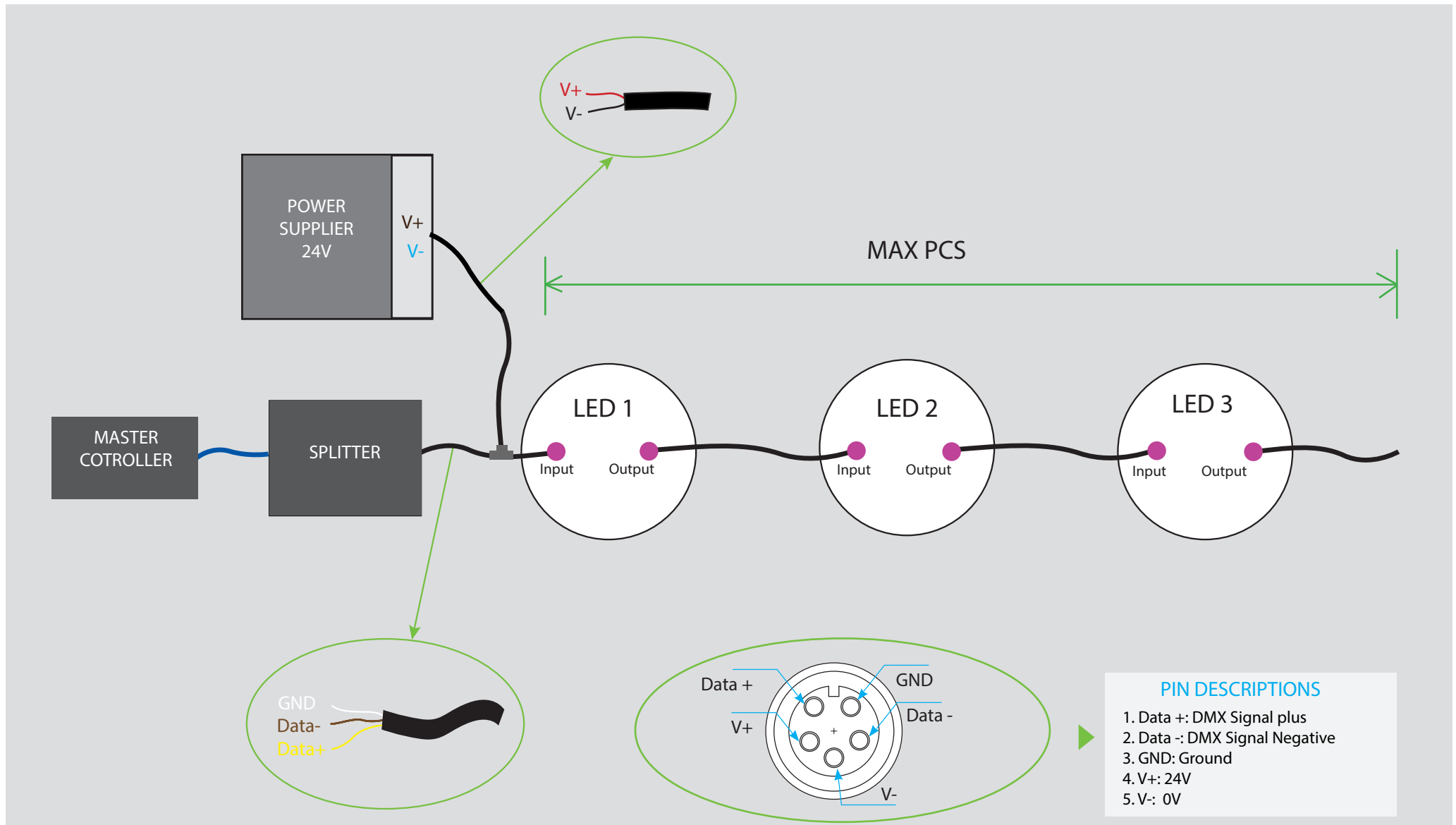

LED INGROUND LIGHT 9W - Applications

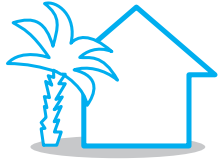

OUTDOOR



LANDSCAPE

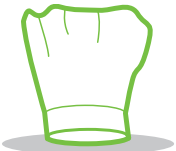

HOTEL/RESTAURANT



FACADE BUILDING



LED INGROUND LIGHT 9W - Applications





THANKS FOR YOUR
ATTENTION